

Montage

Réf notice : WNVC

plaquette de liaison clip de verrouillage

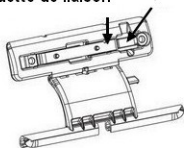

lumières 5 x 8

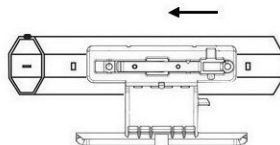
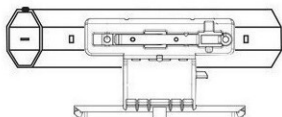
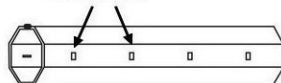

1. Positionner les ergots de la plaquette face aux lumières du tube

2. Pousser latéralement le verrou vers la gauche en maintenant une pression sur la plaquette jusqu'au verrouillage du clip dans la lumière

Démontage

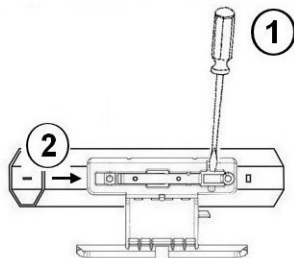

1. Relever le clip de verrouillage à l'aide d'un tournevis
2. Translater le verrou





8

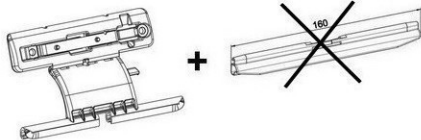

14

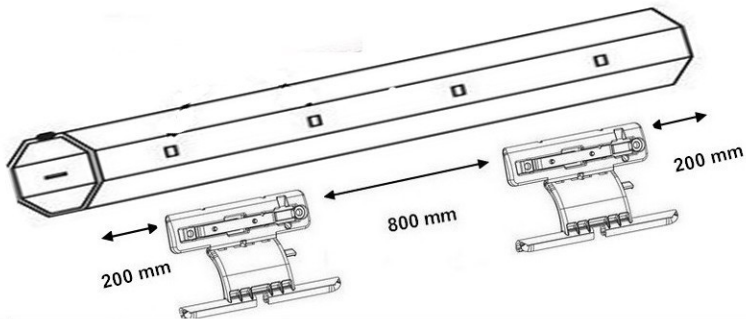
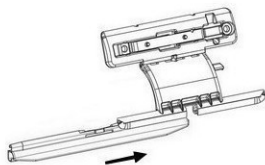
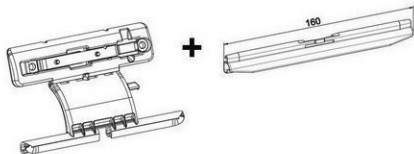

Rq : en cas d'utilisation de moteurs à réglage manuel
le réglage du fin de course bas doit être réglé de manière à éviter
une tension excessive sur les verrous.

Autres renseignements : www.volet-habitat.fr